

C4sun®
high-end sun sails





Handcrafting

Every C4sun shade sail system is a one-of-a-kind product – handcrafted at our production facility in Germany.

»The fabric for every shade sail is cut to the exact dimensions you require, then handcrafted and assembled into a highly durable system.«

If you like standing out from the crowd, you have to follow new paths – even if these sometimes include traditional production techniques. Our sun-shading systems, with their arching sails, create a unique sense of spaciousness. The key to this feature is the use of special, handcrafted battens enclosed in the fabric, known as Clouth profiles. In the furled sail, these Clouth profiles are pressed flat against the winding shaft.



When the sail is unfurled, they automatically arch upwards, forming a spacious fabric dome that creates an unparalleled atmosphere of comfort and well-being. A truly one-of-a-kind quality.

Customers can choose from our three product lines, elips4sun, square4sun and trapez4sun, each of which is associated with a different sail shape. When an order is placed, the fabric for the shade sail is cut precisely to the specified dimensions and then handcrafted and assembled into a complete and highly durable system. The unique know-how of our employees, made-to-order work processes and top-of-the-line materials guarantee many years of excellent performance and outstanding quality.

All individual systems can easily be combined.

In addition to our three product lines, we create completely bespoke solutions for any application. Aimed at providing maximum individuality, these systems constitute a distinct product group called unique4sun. We would also be happy to take responsibility for the management of your project – from the planning and design in line with the overall architectural concept to the production, logistics and professional on-site installation. Because we also provide the same high level of quality in our services, you can look forward to a solution that is not only the most attractive, but also simply the best.



Made in Germany. With the utmost care and precision.



Design

Our shade sail systems outshine everything – with their unique, eye-catching designs.

»The sail arches upwards, creating a sense of spaciousness with an unparalleled atmosphere of comfort and well-being.«

The three C4sun product lines have significant differences – but are all based on the same unique design principle that sets them apart from all conventional sun-shading systems: Their sail arches upwards, creating an unparalleled atmosphere of spaciousness, comfort and well-being. Top-of-the-line materials, such as stainless steel (V2A) and various mast versions, contribute to the overall high-quality appearance.

elips4sun: The ellipsoidal shape, with its curved edges between the ribbing, has a soft, organic look – and only requires a single mast.

square4sun: When it comes to providing uniform, maximal shading for stylish outdoor areas, square4sun is the perfect solution.

trapez4sun: The highly unique, markedly tapered shape creates an attractive contrast to the minimalist designs of surrounding structures.

Unique form follows excellent function: with the characteristic dome shape, rainwater runs right off the sides, and the flexible ribbing easily absorbs gusts of wind. In stronger winds, a specially developed wind-pressure-relief system in the mast prevents excessive strain on the system. Wind pressure is counterbalanced either externally by decorative stone balls in attractive models or internally by special weights in the mast.

With its unique, organic design, C4sun not only creates aesthetic accents but also complements practically all types of surroundings, thanks to numerous options for customisation. The special quality of the C4sun system not only appeals to customers with discerning tastes and an appreciation for stylish ambience – it even impresses professional designers: our elips4sun product line was awarded the R+T Innovation Prize 2015 Special Prize Design and the highly coveted Red Dot Award 2014: Best of the Best.



More than beauty. Exceptional design.



reddot award 2014
best of the best



elips4sun®

The organic look makes the difference – with a distinctive silhouette and exceptional design.

»Unmistakable form with unique function.«

The ellipsoidal shape, with its curved edges between the ribbing, has an extravagant look that stands out distinctively from the uniform appearances of conventional shade sail systems. But the advantages don't stop there: this shape is not only eye-catching but also incredibly practical. The convex edges allow for a wider sail, which offers greater protection from sun and rain. Furthermore, the system only requires a single mast, which saves valuable space for maximum freedom of movement in the shade.

Intelligent shading system also masters strong winds and rain in style.

The Clouth profiles, special handcrafted battens, are responsible for the automatic arching of the sail. Rain-water runs right off the sides without pooling, and the flexible ribbing easily absorbs gusts of wind. In stronger winds, a specially developed wind-pressure-relief system in the mast prevents excessive strain on the system. The result: a unique atmosphere of comfort and well-being in any weather. Like all other C4sun products, every elips4sun system is a custom-made, automatically furling, one-of-a-kind shade sail.

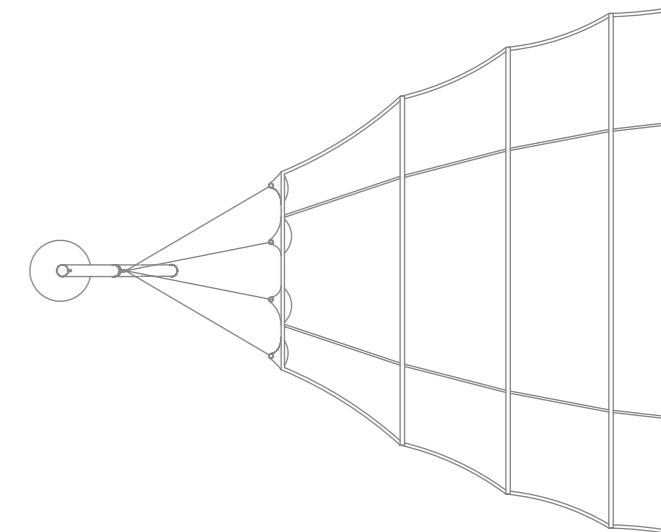

A new form of comfort and protection.

What sets the elips4sun shade sail apart from conventional systems is its eye-catching design with curved edges between the ribbing. The space-saving construction only requires one tensioning cable and a single mast. Discover a completely new outdoor-living ambience, and enjoy this exceptionally attractive style of comfort and protection!



System Components, Standard Version

- Stainless-steel (V2A) AG101 mast: \varnothing 101.6 mm, L 5,240 – 5,840 mm including BRAVO granite ball as external weight
- Wind-pressure-relief system integrated into the mast
- Stainless-steel winding shaft 101.6 x 3 mm
- Two wall brackets for mounting the shaft to the wall
- Tubular drive, drive cables, remote control
- Sail with Clouth profiles and screw-tensioning system

Other optional features and equipment can be found in the sections *Comfort* and *Customisation Options*. Further mast models (available at additional cost) are shown on the following two pages.



Award Winning!

The elips4sun, with its unique form and function, is not only turning heads but also impressing juries. It earned the R+T Innovation Prize 2015 Special Prize Design as well as one of the world's most prestigious design awards: the Red Dot Award 2014: Best of the Best.



reddot award 2014
best of the best





AG101*



IG204



IG211

AG101* Round mast (ø101 mm) with internal wind-pressure-relief mechanism and external weight: a granite ball available in various models.

IG204 Round mast (ø 204 mm) with internal wind-pressure-relief mechanism and internal weights.

IG211 Square mast (211 x 211 mm) with internal wind-pressure-relief mechanism and internal weights.

All masts are also available in V4A stainless steel (additional cost).

elips4sun Mast Information

Model	AG101*	IG204	IG211
Weight	external ball BRAVO included	internal	internal
Installation angle	79° angle	90° angle	90° angle
Dimensions			
Diameter	ø 101.6 mm	ø 204.0 mm	211 x 211 mm
Height	5,240 - 5,850 mm	3,000 mm	3,000 mm
Mounting Options			
Krinner ground screw	yes	yes	yes
Concrete foundation	ground socket ø 108 x 3 mm Length: 700 mm	use C4sun Flange Plate	use C4sun Flange Plate
C4sun Cube	-	yes	yes
C4sun Wall Brackets	-	-	-

* BRAVO ball included, other balls available at additional cost.

See section on *Customisation Options*.

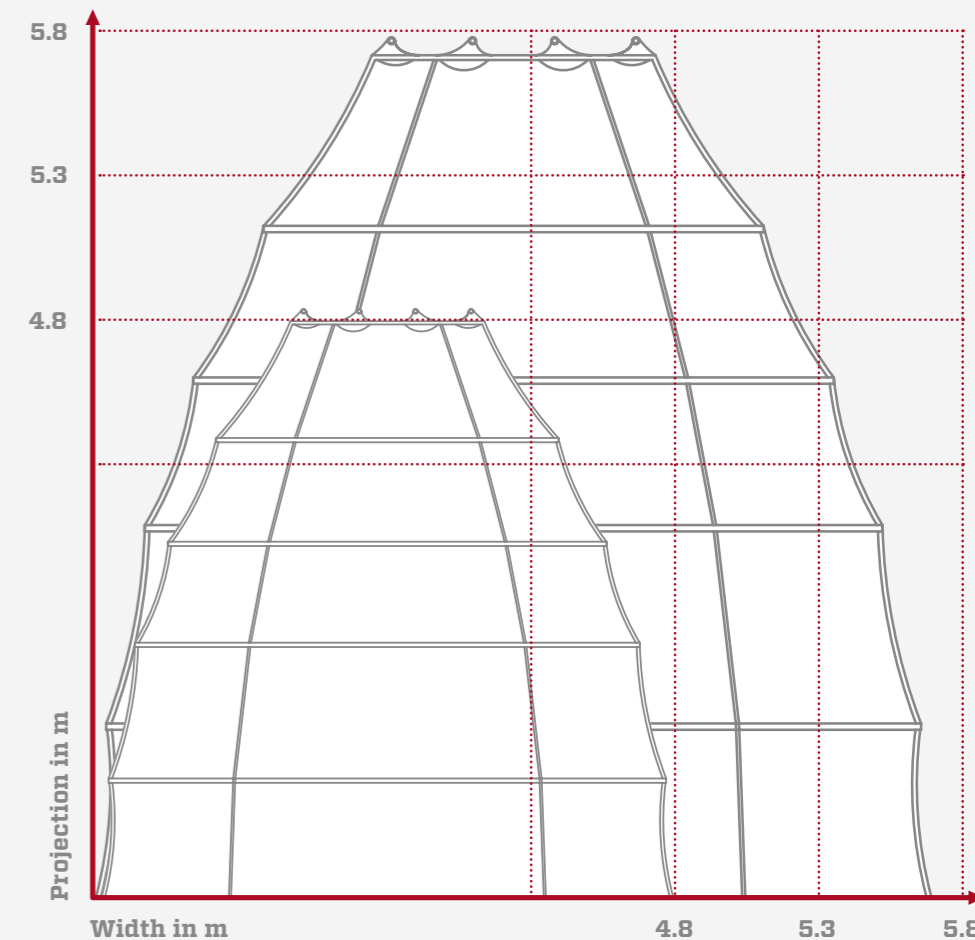

Custom sizes available.

Requirements: projection equal to or greater than width.

Other dimensions available upon request.

square4sun®

Innovative shade sail system in top form:
square – and nevertheless out of the box!

»A timeless classic:
unique in its design –
and precision engineered
down to the smallest detail.«

When it comes to providing uniform, maximal shading for luxury outdoor areas, square4sun is the perfect solution. The dome shape of the unfurled sail – with its stylishly sophisticated spaciousness and unique atmosphere of comfort and well-being – never gets boring. The variety of available mast types, specially developed wind-pressure-relief systems and mast-positioning options also have a significant effect on the overall appearance. These choices and options enable you to customise the system to its surroundings. The automatic arching of the sail is not only attractive – it also offers optimal protection from wind and weather. Rainwater runs off, effectively preventing unwanted water pockets, and the sail even maintains its shape and stability in strong winds.

Stands out where
other systems fall flat.

The highly elastic Clouth profiles arch upwards to create a dome shape when the sail is unfurled and lie flat against the shaft when the sail is furled: this is what makes it possible to wrap a three-dimensional awning onto a smooth shaft – and guarantee long-lasting, reliable functionality. The winning combination of high-quality materials and intelligent technical details makes the square4sun a timeless classic of design.

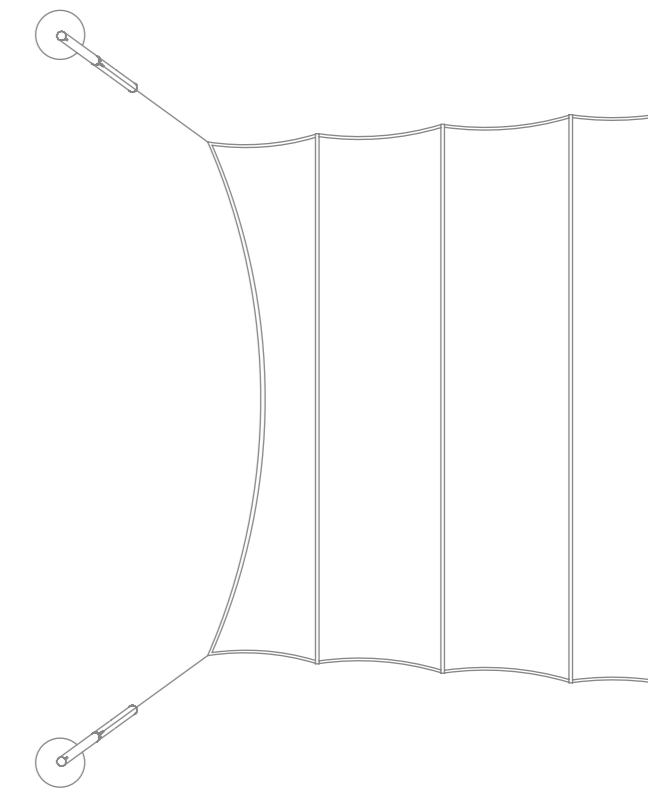

Straight lines with a distinctive character.

The square4sun is available in various models and sizes. As a result, it is easily adaptable to the architecture and requirements of the surroundings, as well as to your personal tastes. These square sails, with their large surface area, provide significantly more shading, protection and style than conventional products.



System Components, Standard Version

- Two stainless-steel (V2A) AG101 masts: \varnothing 101.6 mm, L 5,240 – 5,840 mm including BRAVO granite balls as external weights
- Wind-pressure-relief system integrated into the mast
- Stainless-steel winding shaft 101.6 x 3 mm
- Two wall brackets for mounting the shaft to the wall
- Tubular drive, drive cables, remote control
- Sail with Clouth profiles and screw-tensioning system

Other optional features and equipment can be found in the sections *Comfort* and *Customisation Options*. Further mast models (available at additional cost) are shown on the following two pages.



Two different models - both one of a kind.

In order to offer you even more installation options, this sail type is available in two models with different mast positions and cable-routing systems. The masts of the model »square4sun cross« are spaced slightly wider than the fabric for an especially stable sail. The masts of the »square4sun line« are aligned with the front corners of the sail. The parallel lines formed by the cables accentuate the convex shape of the sail.





AG101*

IG101

IG204

IG211

AG101* Round mast (ø101 mm) with internal wind-pressure-relief mechanism and external weight: a granite ball available in various models.

IG101 Round mast (ø 101 mm) with internal wind-pressure-relief mechanism and internal weights.

IG204 Round mast (ø 204 mm) with internal wind-pressure-relief mechanism and internal weights.

IG211 Square mast (211 x 211 mm) with internal wind-pressure-relief mechanism and internal weights.

All masts are also available in V4A stainless steel (additional cost).

square4sun Mast Information

Model	AG101*	IG101	IG204	IG211
Weight	external ball BRAVO included	internal	internal	internal
Installation angle	79° angle	90° angle	90° angle	90° angle
Dimensions				
Diameter	ø 101.6 mm	ø 101.6 mm	ø 204.0 mm	211 x 211 mm
Height	4,500 mm 5,240 mm 5,850 mm	4,500 mm 5,240 mm 5,850 mm	3,000 mm	3,000 mm
Mounting options				
Krinner ground screw	yes	yes	yes	yes
Concrete foundation	ground socket ø 108 x 3 mm Length: 700 mm	ground socket ø 108 x 3 mm Length: 700 mm	use C4sun Flange Plate	use C4sun Flange Plate
C4sun Cube	-	-	yes	yes
C4sun Wall Brackets	-	yes	-	-

* BRAVO ball included, other balls available at additional cost.

See section on *Customisation Options*.

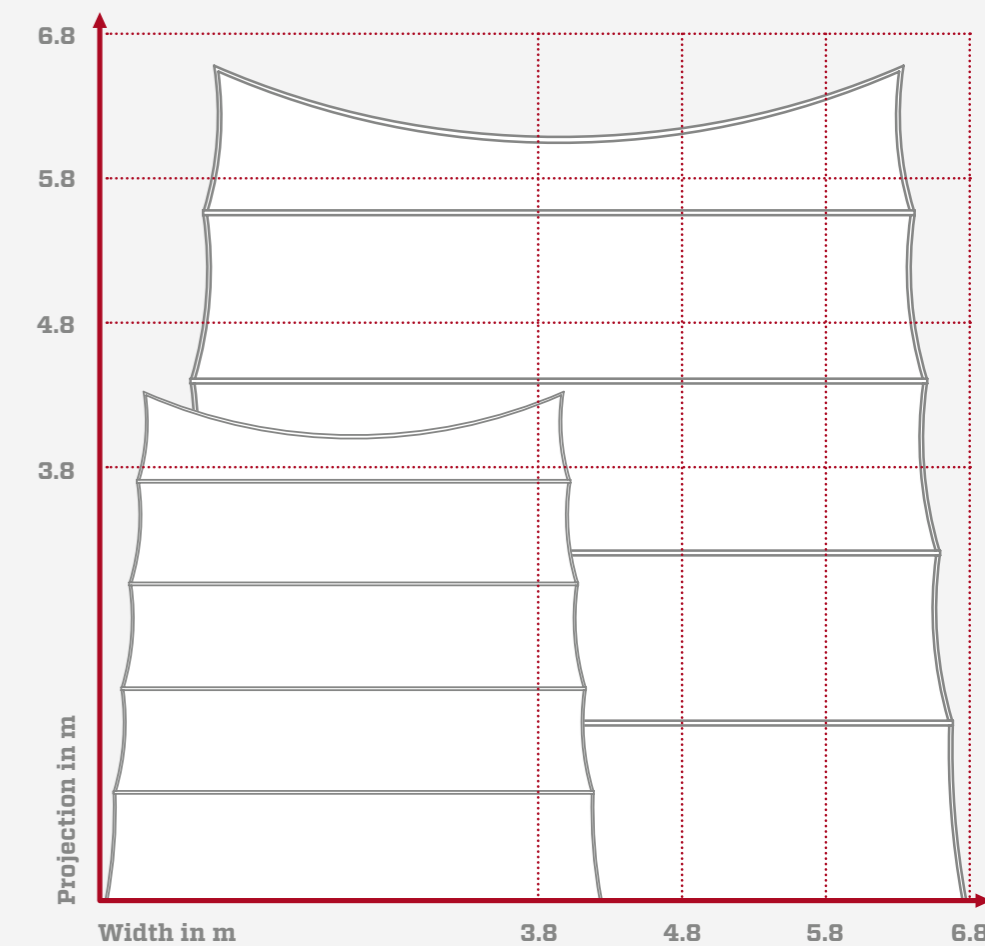

Custom sizes available.

Other dimensions available upon request.



»Nowadays, individuality is the greatest luxury.«

trapez4sun®

The best remedy for the humdrum of life: lots of light, fresh air and inspiration.

Few products illustrate this better than the shade sails from C4sun. The elegant trapez4sun shade sails have an eye-catching design that outshines all conventional systems. The trapez4sun system was designed to suit your unique tastes and dynamic personality. The sail has a distinctively tapered shape that creates an attractive contrast to minimalist architecture or the strictly symmetrical designs of surrounding structures.

Turning style into an experience.
In any weather.

The trapezoidal sail is a real head turner – and is also the first choice for unusually shaped terraces requiring an effective and visually appealing sun-shading solution. The system furls and unfurls fully automatically, and the unique atmosphere of comfort and well-being under the arched sail turns every second spent outdoors into a magical moment – in any weather. Rainwater runs off the sides quickly and reliably. With its perfect balance of flexibility and stability, the system masterfully withstands even strong gusts of wind. As one of the most innovative products on the market, the trapez4sun – like all other C4sun systems – can be easily integrated into modern »smart home« solutions.

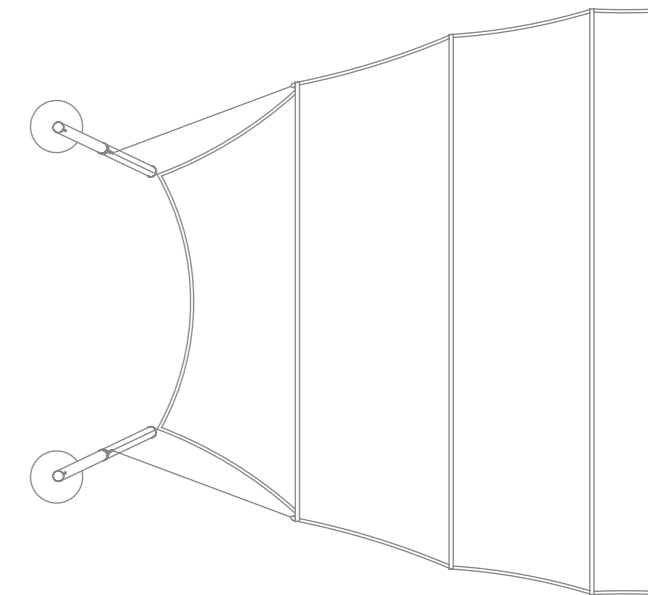

Attractive shapes inspire – and open up new perspectives.

Instead of following the trends, C4sun prefers to set new standards. With innovative ideas and exceptional solutions like the trapez4sun – an inspiring shade sail that opens new horizons with its design. Ideal for anyone who wants the time they spend outdoors to be filled with unique moments.



System Components, Standard Version

- Two stainless-steel (V2A) AG101 masts: ø 101.6 mm, L 5,240 – 5,840 mm including BRAVO granite balls as external weights
- Wind-pressure-relief system integrated into the mast
- Stainless-steel winding shaft 101.6 x 3 mm
- Two wall brackets for mounting the shaft to the wall
- Tubular drive, drive cables, remote control
- Sail with Clouth profiles and screw-tensioning system

Other optional features and equipment can be found in the sections *Comfort* and *Customisation Options*. Further mast models (available at additional cost) are shown on the following two pages.

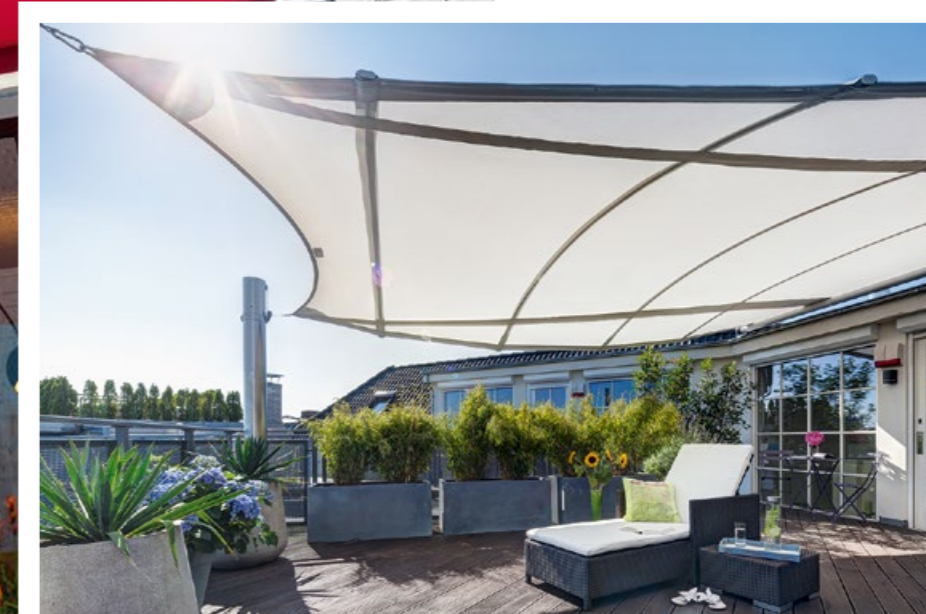

Enjoy freedom – wherever you are. With smart home solutions from Somfy and C4sun.

You can keep everything under control at all times with the TaHoma system from Somfy, the global market leader in home automation. This system allows you to operate your C4sun shade sail system conveniently via remote control, computer or smartphone app. Or you can simply leave it up to the wind and sun sensor, which reliably monitors and responds to changes in the weather and light conditions around the clock.



AG101*

IG101

IG204

IG211

AG101* Round mast (ø101 mm) with internal wind-pressure-relief mechanism and external weight: a granite ball available in various models.

IG101 Round mast (ø 101 mm) with internal wind-pressure-relief mechanism and internal weights.

IG204 Round mast (ø 204 mm) with internal wind-pressure-relief mechanism and internal weights.

IG211 Square mast (211 x 211 mm) with internal wind-pressure-relief mechanism and internal weights.

All masts are also available in V4A stainless steel (additional cost).

trapez4sun Mast Information

Model	AG101*	IG101	IG204	IG211
Weight	external ball BRAVO included	internal	internal	internal
Installation angle	79° angle	90° angle	90° angle	90° angle

Dimensions				
Diameter	ø 101.6 mm	ø 101.6 mm	ø 204.0 mm	211 x 211 mm
Height	4,500 mm 5,240 mm 5,850 mm	4,500 mm 5,240 mm 5,850 mm	3,000 mm	3,000 mm

Mounting options				
Krinner ground screw	yes	yes	yes	yes
Concrete foundation	ground socket ø 108 x 3 mm Length: 700 mm	ground socket ø 108 x 3 mm Length: 700 mm	use C4sun Flange Plate	use C4sun Flange Plate
C4sun Cube	-	-	yes	yes
C4sun Wall Brackets	-	yes	-	-

* BRAVO ball included, other balls available at additional cost.
See section on Customisation Options.

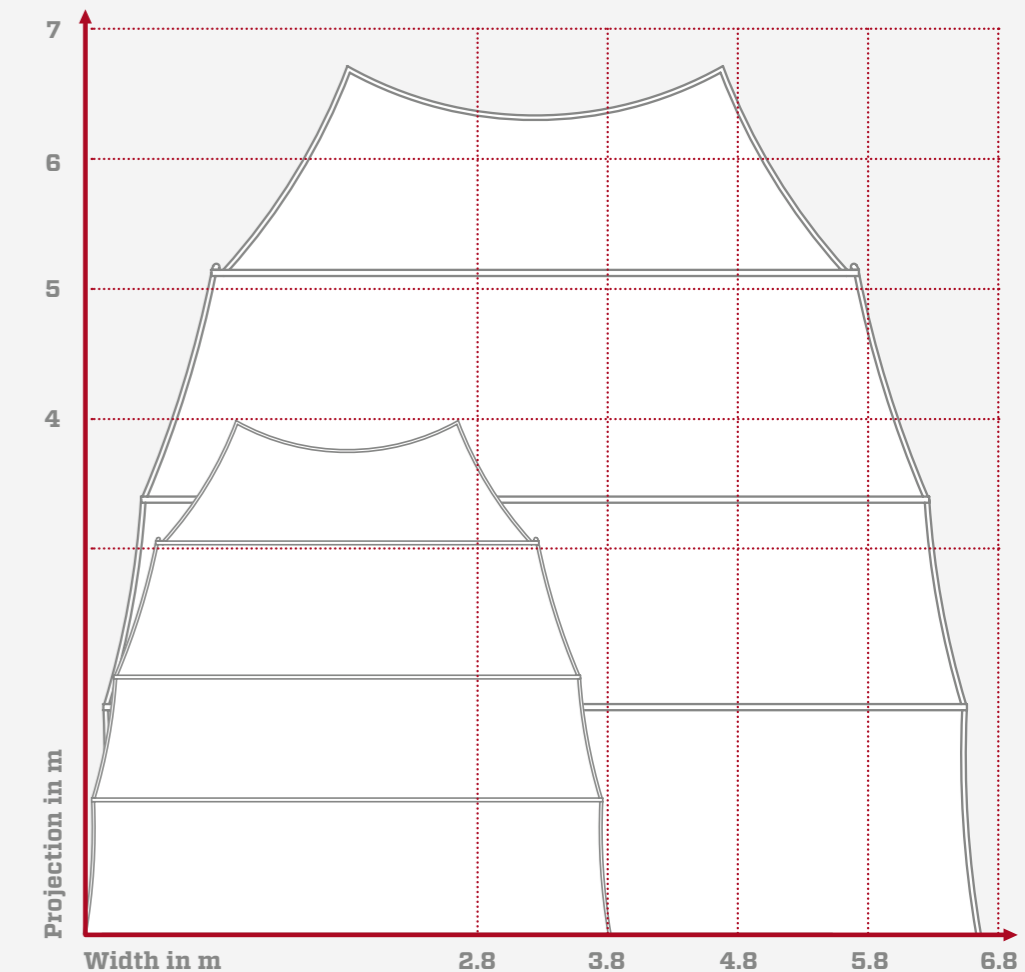

Custom sizes available.
Requirements: projection equal to or greater than width.
Other dimensions available upon request.



unique4sun®

One of a kind, like your personality –
and perfectly tailored to your requirements.

»Turning individuality into a
high-end solution.«



For anyone who would rather set standards than settle for standard solutions, C4sun is the right partner for customised shading concepts. Higher standards and more demanding projects require more professional consultation, planning, coordination and implementation. This is the only way to implement maximum individuality as a long-term and reliable high-end solution that outshines all other systems.

You profit from our extensive experience in product development and quality improvement. This applies not only to construction-related features and special characteristics, but also to designs, materials and the technologies we use. From our daily work, we know the strengths of the various components, such as wind-pressure-relief systems, drive systems and control options, and can therefore find the best solution fast.



Custom-developed solutions for practically all types
of surroundings and requirements: unique4sun.

A combination or completely new design: the choice is yours!

New and exceptional shading concepts can be developed by simply combining our existing product lines – elips4sun, square4sun and trapez4sun – and using bespoke solutions for installation and assembly. If this approach does not produce the desired results, then we would be happy to work in close cooperation with you, your architect and/or your builder to develop completely new, one-of-a-kind shading concepts and designs.

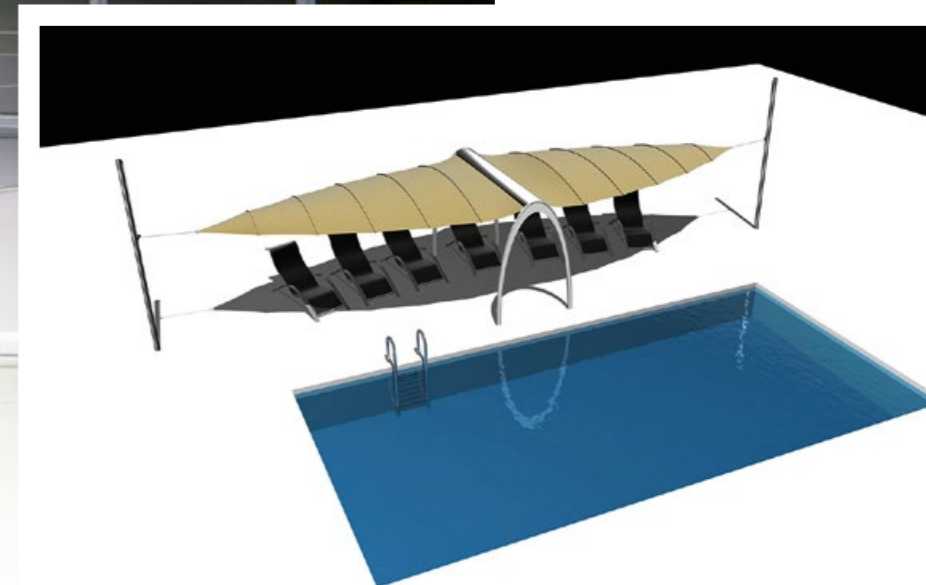
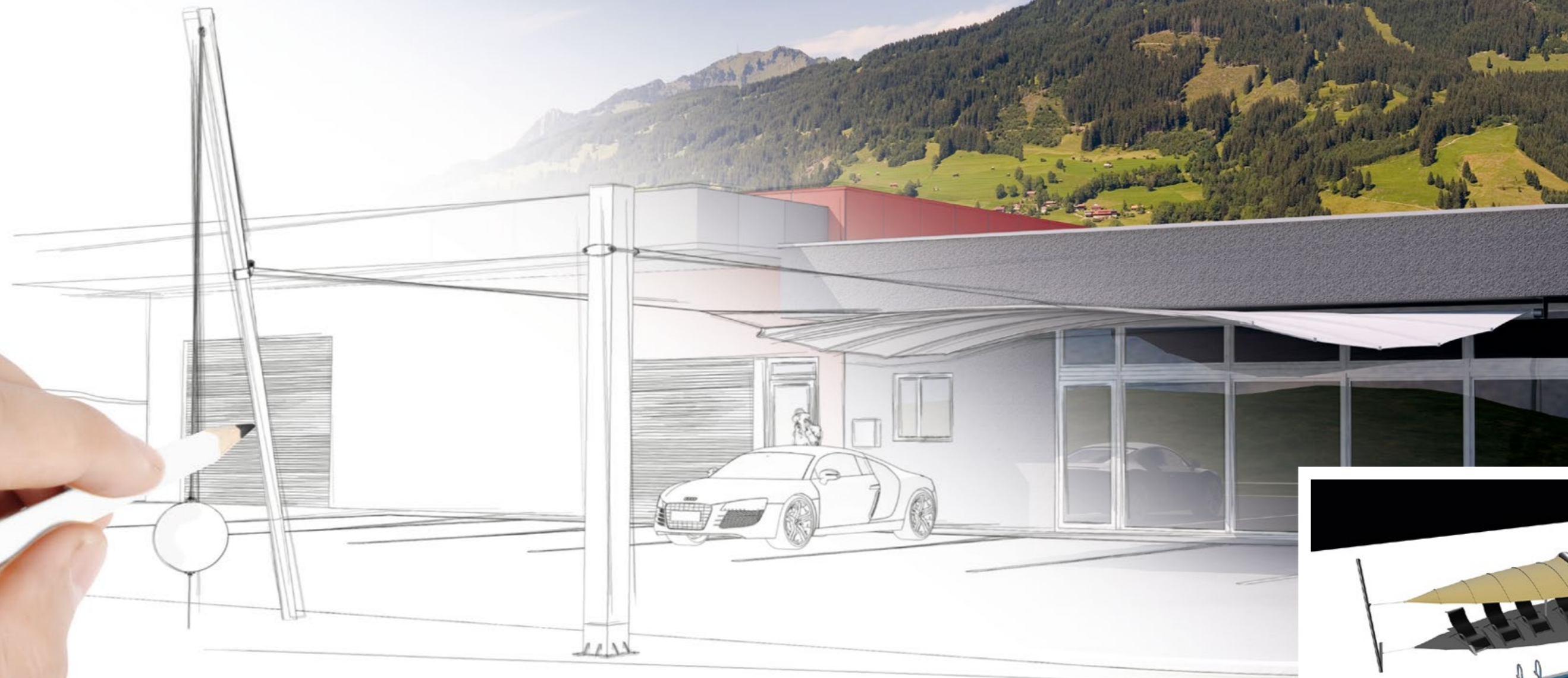

We also provide personal and competent consultation throughout the entire development process. Our range of services includes on-site needs assessment, consultation on technical possibilities, seamless integration into the overall architectural concept, transport logistics, and professional on-site installation.

We also take the time to show you how to operate, maintain and service your new C4sun system. And all our services are delivered with the same exceptional quality as our products. Contact us. We'd be happy to provide you with an individual quote.



www.shutterstock.de

»We've taken care of the important things so that you can relax.«

With a one-of-a-kind design principle and fascinating detail solutions that make your life easy. Enjoy the convenience! Take, for example, the controls: at the touch of a button on the remote control or wall-mounted transmitter, the sail unfurls effortlessly. Your outdoor area is transformed into a stylish stage, and shade becomes a fascinating experience. As the sail unfurls from the shaft, the Clouth profiles – special battens enclosed in the sail – arch upwards, giving the sail its distinctive dome shape and creating an unparalleled atmosphere of comfort and well-being. Automatically. With the optimal sun-shading and rain-protection system, you can relax outdoors in any weather. Rainwater runs right off the sides, thanks to the convex shape of the »roof«.

Comfort

Relax and enjoy your valuable time outdoors – in pure luxury, a standard feature of every C4sun system.

Gusts of wind are elegantly absorbed by the Clouth profiles and the specially developed wind-pressure-relief system. And maximum comfort means always playing it safe in the worst conditions: if the wind becomes so strong that it could potentially pose a hazard for people or the system itself, the sail furls away automatically.

Even the maintenance requirements will put you at ease.

The high-quality, extremely weather-resistant materials, tried-and-tested technical components and durable overall construction reduce care and maintenance requirements to a minimum. This guarantees an attractive appearance and reliable function for many years of carefree enjoyment. So that you can concentrate on the truly important things: enjoying your valuable time outdoors in style.



Optional components like this wind sensor offer maximum comfort and convenience.

»Is there really such a thing as ultimate comfort?«

We were able to answer this question with a resounding yes – and with clever comfort options that make your life easier. Even when you're not at home.



Somfy io-homecontrol

- Sunea 60 io motor 120/12
- Situo Mobile io hand-held remote control
- Eolis WireFree io wind sensor
- Sunis WireFree io sun sensor
- Sensor Box io
- Smoove 1 io wall-mounted control unit
- TaHoma Box



io-homecontrol hand-held and wall-mounted control units

The intelligent optional features and equipment for our sun-shading systems can provide you with mobile access to the basic control functions when you're relaxing in your car, at work or on holiday across the ocean. These options include the seamless integration of compatible drive and control components into existing bus home automation systems or in the TaHoma smart home system from Somfy, which communicates with connected components via the tried-and-tested io-homecontrol radio control system. These technologies make it possible to monitor and control any C4sun shade sail via app. From the comfort of your tablet, laptop, computer or smartphone. Whenever you want. Wherever you are.

You can either take the control in your own hands, e.g. using RTS radio frequency technology – or let the system do all the work. For example, the optional Soliris wind and sun sensor continually monitors sun intensity and wind speed. If the measured values exceed the pre-set limits, the sail will automatically furl or unfurl. For more safety and perfect outdoor conditions.

Somfy RTS System

- Altus 60 RTS 120/12 motor
- Telis 16 RTS hand-held remote
- Soliris wind and sun sensor

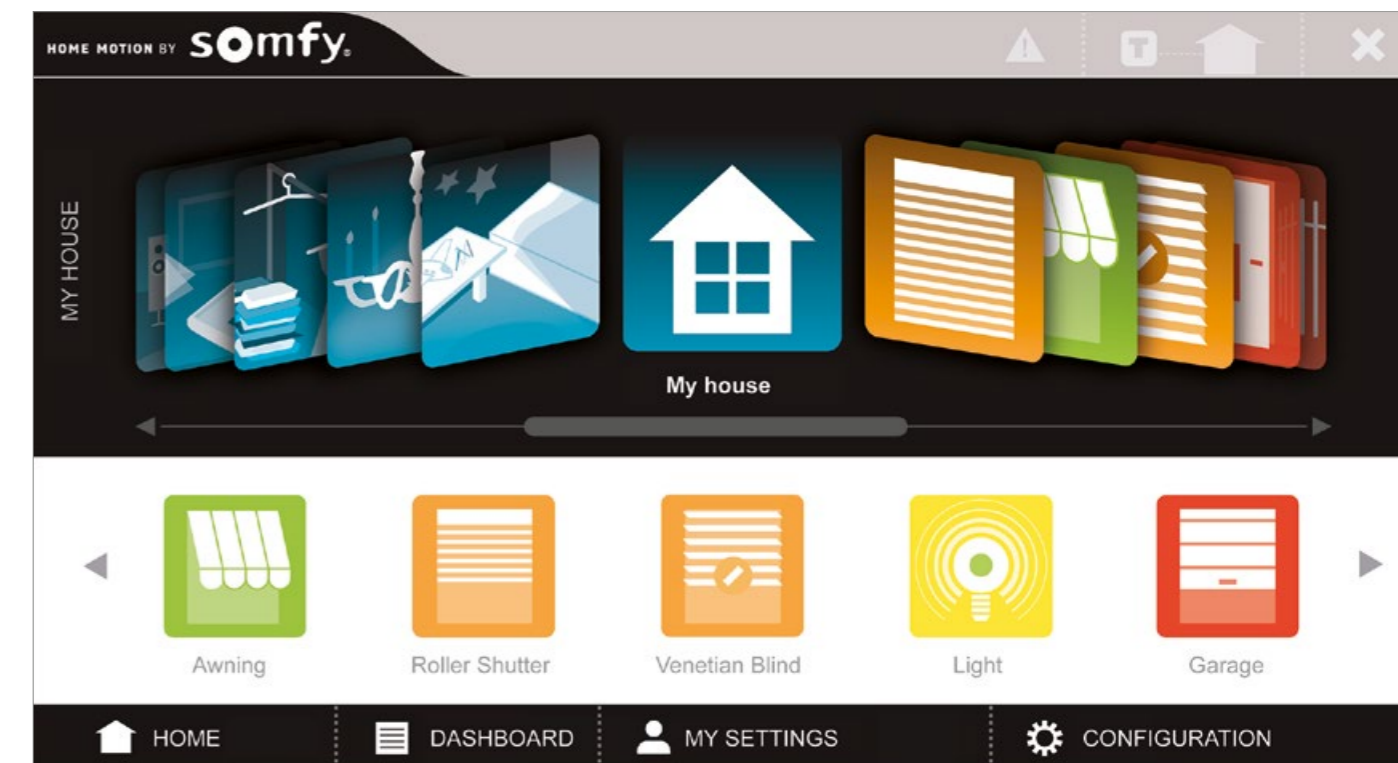



»Our most complex task: ensuring that everything works effortlessly.«

When we're in the process of developing products, we often have to think out of the box. This means taking the good and making it better and sometimes even finding completely new solutions for seemingly unsolvable problems. Now, we can proudly say that we have accomplished everything we set out to do - and that the often rocky road has paid off. Because if you choose a C4sun system, you no longer have to worry about technical details. You can simply concentrate on the important things, like enjoying every minute of your valuable time outdoors. Under a shade sail that elegantly combines extraordinary aesthetics with excellent function and maximum comfort and convenience. Fully automatic. Reliable. Robust. Safe.

Where others fall flat, these stand tall: Clouth profiles.

The key to the unique atmosphere of comfort and well-being created by the C4sun shade sails are the highly elastic Clouth profiles, which are enclosed in the fabric crosswise to the opening direction. In the furled sail, these special, handcrafted battens are pressed flat against the winding shaft. When the sail is unfurled, their

Precision engineered, down to the smallest detail, leaving you worry-free.

ensioning causes them to automatically curve upwards, giving the fabric a dome shape. Wind pressure is easily absorbed, and there is no way for rainwater to collect in pockets. However, we do recommend furling the shade sail in snowy weather.

Engineered for wind stability.

A specially developed pulley system in the mast provides reliable wind-pressure relief. Excessive wind pressure is counterbalanced by either internal weights or a highly visible, decorative granite ball. Special, high-quality components, such as free-gliding pulleys, guarantee that the complex mechanism will operate without unpleasant noises, even in gusting wind. In extremely windy weather, the sail senses when it's time to »fold«, furling away fully automatically.

Everything under control.

Our motivation has always been to offer you solutions that are the best in every possible way. This is why we've chosen to work with the companies Becker and Somfy for our drive and control systems. The trusted components of the global leader Somfy, such as shaft motors, operating elements and control sensors - as well as its sophisticated smart home solutions - meet even the toughest requirements for efficiency, reliability and safety.

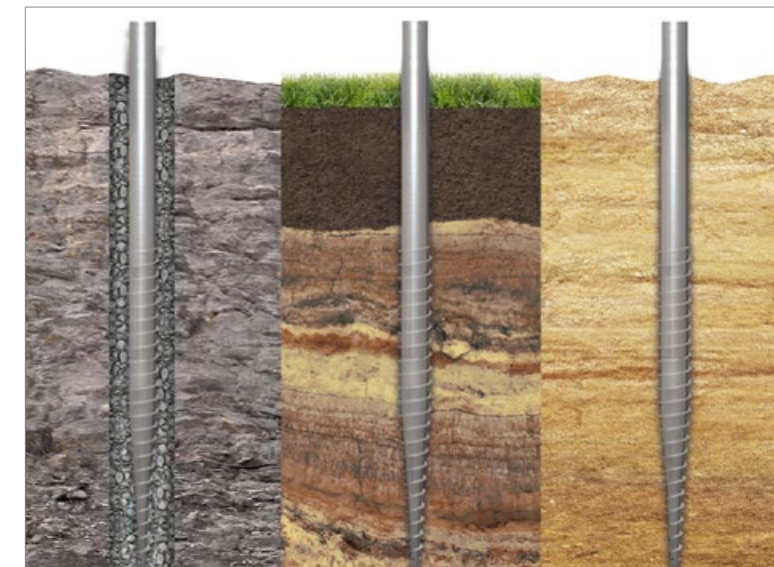

The perfect solution for every ground:

Krinner ground screws.

Free choice: always the best solution!

Ground properties can vary greatly. Even at a single building site. If this applies to the area under your planned shade sail, e.g. if various surface materials were used, you can simply combine any of the mounting solutions described here.

Upon request, we would be happy to develop a customised installation concept to suit your outdoor area and the surrounding structures. In this way, maximum individuality and professional installation lead to an outstanding result.

Installation tips.

To ensure safe operation, the system must be installed by qualified professionals. The only hardware required for mounting the winding shaft to the building wall are two brackets - custom-made, stainless-steel wall brackets with special shaft mounts.

If the shade sail cannot be mounted directly to the building, we will work with you to develop a customised installation solution taking into consideration your outdoor area and the surrounding structures. For free-standing systems, we also offer special installation solutions that are perfectly tailored to our shade sails.

C4sun Cube.

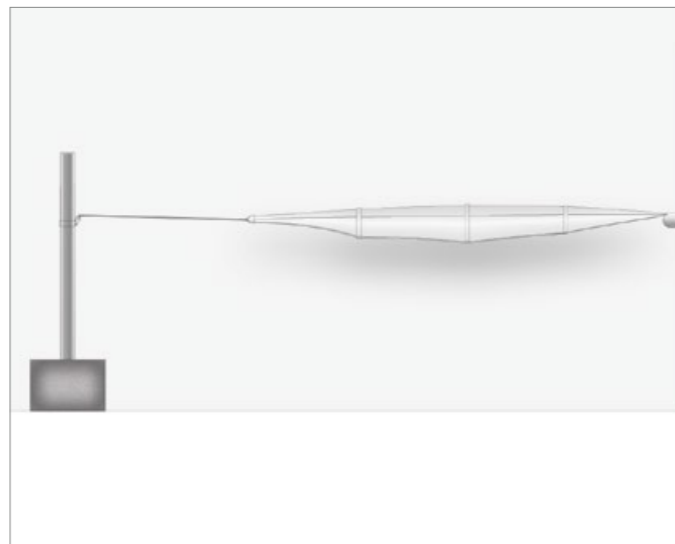

The ideal solution for terraces, particularly roof terraces: Our cubes measure 80 x 80 x 40 cm and can be placed anywhere on flat surfaces. For safety purposes, they are either weighted with up to 400 kg of ballast material or anchored to the ground. The choice is yours: as a place to sit or a decorative planter - our impressively multifunctional cubes are so much more than simply stable bases for masts.

C4sun Wall Bracket.

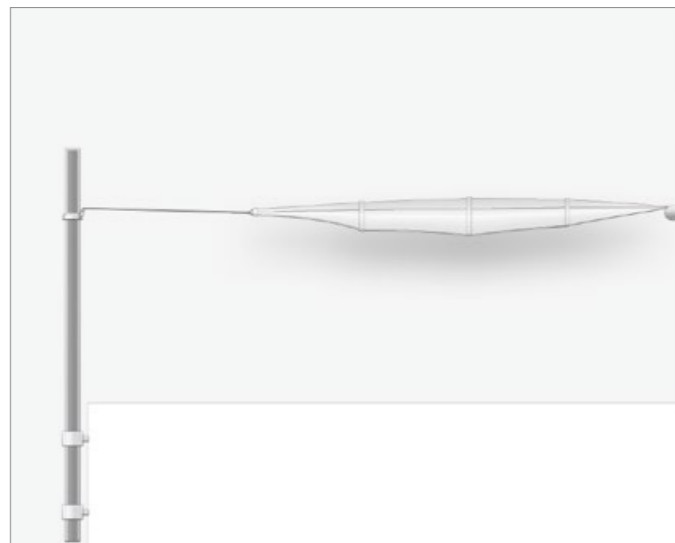

Wall brackets are used for mounting mast systems parallel, cleanly and securely to an existing wall. This mounting system guarantees maximum freedom of movement - the shaded area can be used freely, with no obstacles.

Krinner ground screw.



With ground screws, the masts can be anchored to the ground quickly, cleanly and securely. This patented foundation system from the German company Krinner is an excellent alternative to concrete foundations. The ground screws are driven into the ground quickly and easily using special equipment. The conical shape compacts the soil around the screw, producing the required stability. Therefore, no time-consuming excavation work is necessary. In comparison to concrete foundations, this method is extremely fast, environmentally friendly and clean.

C4sun Flange Plate.

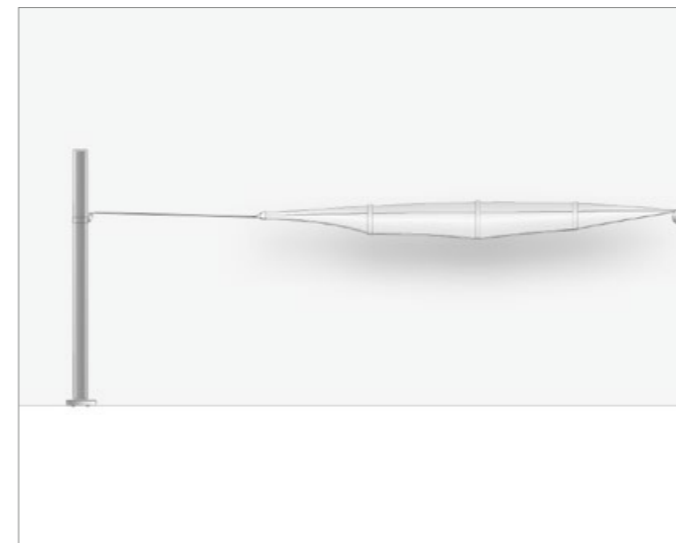

Our base flange plates are the best choice if you plan to place your mast systems on an existing foundation or a level surface. This solution is ideal for the installation of a shade-sail system on existing terraces.



Standard Colours

For its sails, C4sun uses exclusively WeatherMax 80, a high-strength fabric that is both breathable and extremely watertight. With a fabric weight of 270 g/m², it combines high tear strength with an optimal elastic recovery and excellent colour brilliance and fastness. WeatherMax 80 is resistant to mould and mildew and offers maximum protection from glare and UV rays.

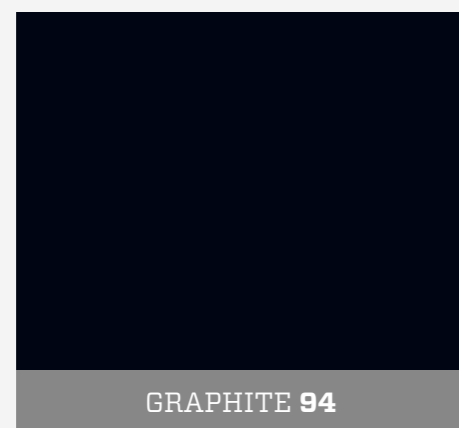
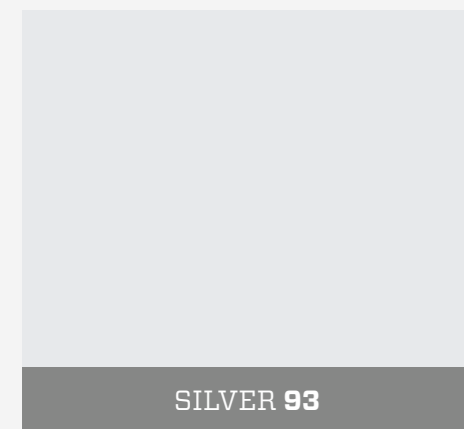

Special Colours

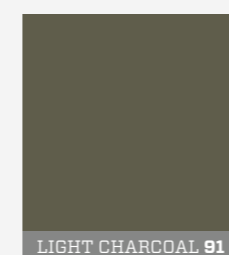
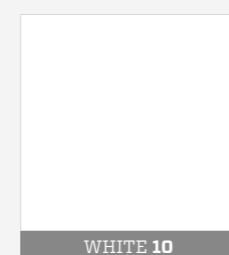
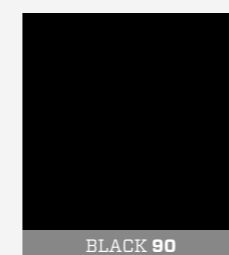
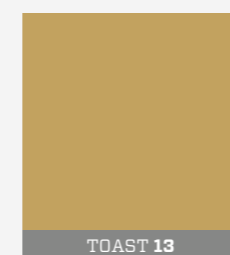
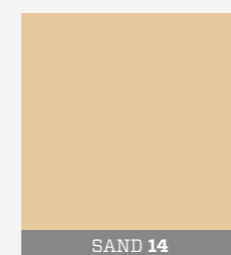

Customisation Options

Every shade sail from C4sun is already a one-of-a-kind, handcrafted product, but our options let you add even more individuality.

Every C4sun shade sail is handcrafted to the desired format and size. In addition to the four standard colours, a further 16 colour options are available, enabling you to customise the sail design to fit ideally to the surroundings and your personal tastes. The colours shown on the left are only intended as a guide. Before selecting a colour, please contact us to request a set of fabric samples.

There are also several mast models to choose from. Detailed information can be found on the info pages for the respective product lines. For the AG101 mast with an external weight, we offer additional high-quality stone-ball models as alternatives to the basic model BRAVO. All available models are shown on this page.

You also have several options in the configuration of your individual control and operating concept, which we describe on the »Comfort« pages of this catalogue. We would be happy to provide you with in-depth information about the advantages of the available systems and components.



Granite ball BRAVO



Granite ball SOL



Granite ball GALA



Granite ball NERO



Our Company

C4sun has become an innovation leader – with high-tech, know-how and passion.

»All success stories begin in the same place. The head.«

It all began in 2011 with the development of the C4sun concept. The principle: a highly aesthetic shade sail with an elegant dome shape that furls and unfurls fully automatically. A customised solution for luxury terraces and sophisticated outdoor areas that outshines all other systems with its innovative design and a completely new atmosphere of stylish spaciousness.

Accomplishing our goals with dedication, creativity and innovative solutions.

In order to advance the project from the concept stage to series production, Joh. Clouth began providing support for the development of the company in 2011. Based in Hückeswagen, Germany, this family-owned company is a global market leader and supplier to the paper industry.

Joh. Clouth invested not only capital but also its collective know-how and a lot of passion into the further development of the product, processes and production. The key elements of the shade sail are the Clouth profiles, special handcrafted battens that are responsible for the automatic arching of the sail.

Looking forward to a sunny future.

C4sun GmbH has been well positioned for the global market since 2014. It boasts a unique product portfolio, personalised, product-related services, its own production facility in Hückeswagen and a successfully growing network of exclusive sales partners both in Germany and abroad – as well as the unconditional support of a genuine global player: the company group Clouth.



Quality is at home in Germany –

our production facility in Hückeswagen.

Bahama GmbH
Gewerbeparkstr. 34 | D-51580 Reichshof
T +49 (0)2265 998 0 | F +49 (0)2265 998 300
info@bahama.de | www.bahama.de